



Jeep Patriot

Front Air Deflector

Genuine Accessories



A

X4



X4



X2



B

C

D

E

Tools Required / HERRAMIENTAS NECESARIAS / OUTILS NECESSAIRES

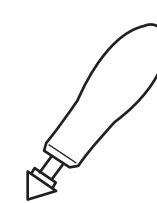
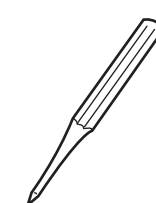
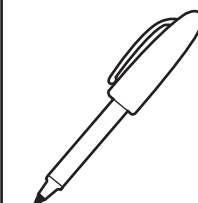
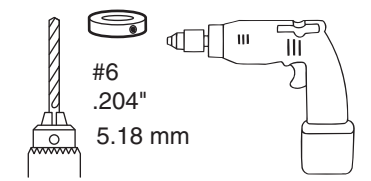
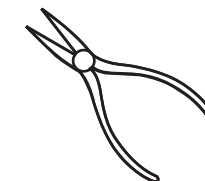
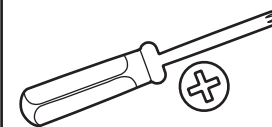



Jeep Patriot

Front Air Deflector

Genuine Accessories

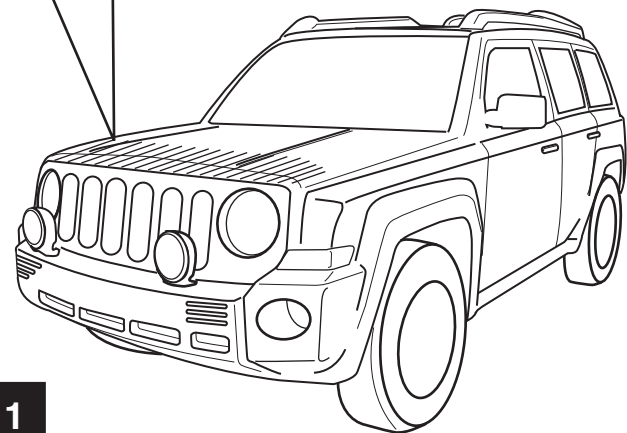
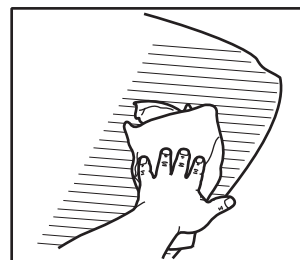

1

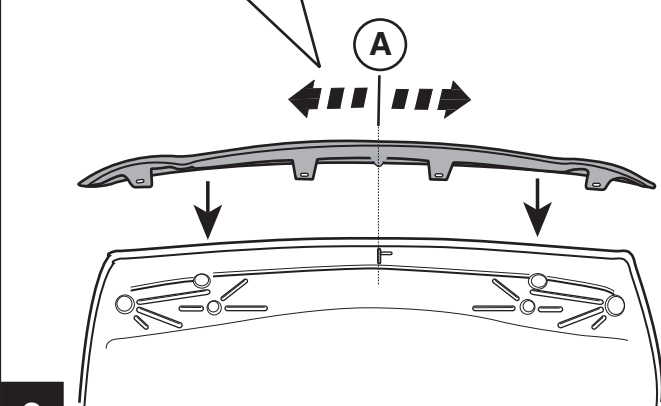
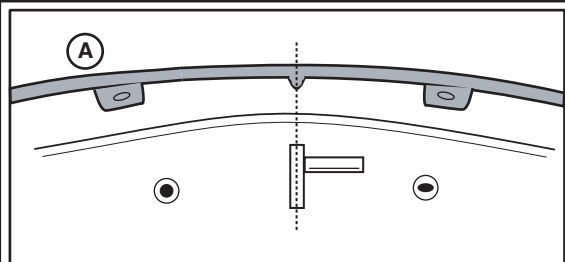

2

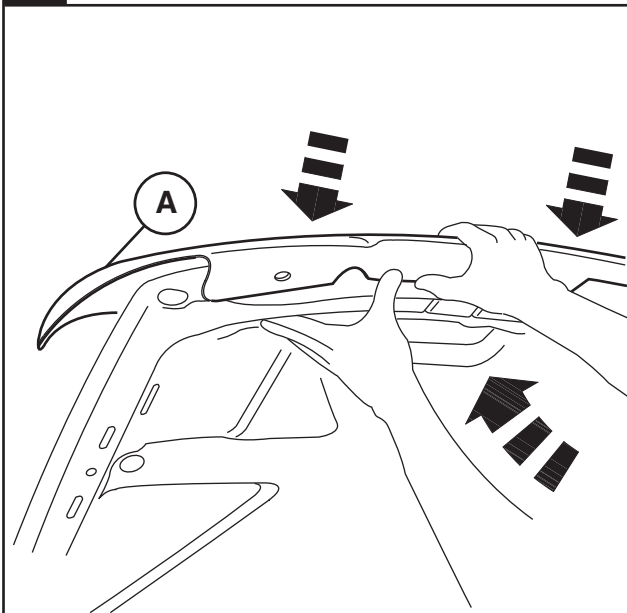

3

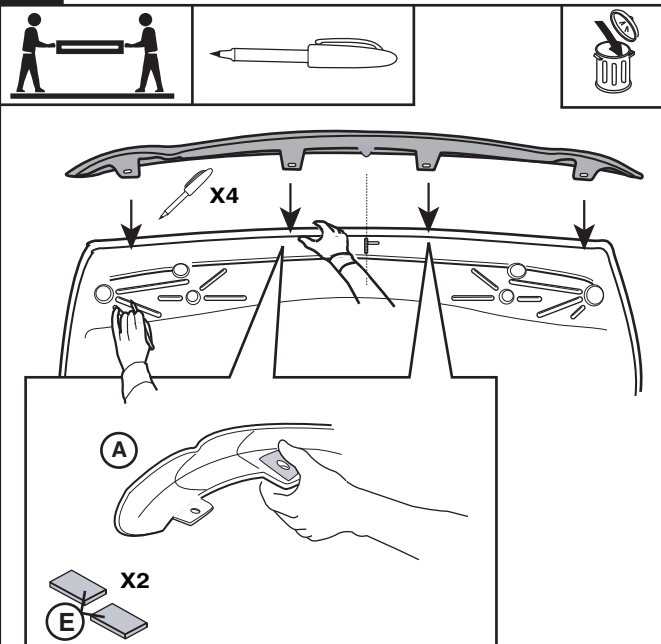

4



Jeep Patriot

Front Air Deflector

Genuine Accessories

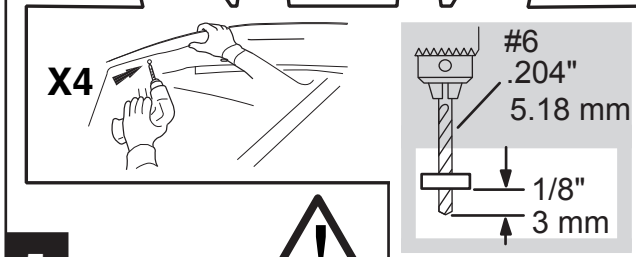
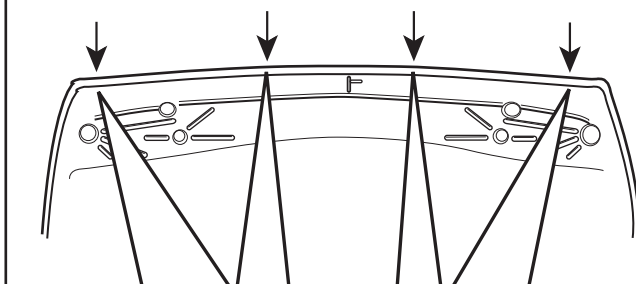
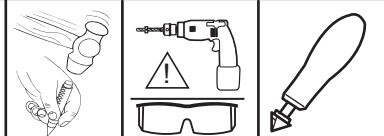

5

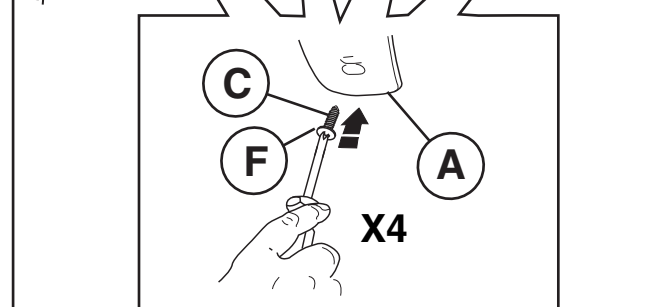
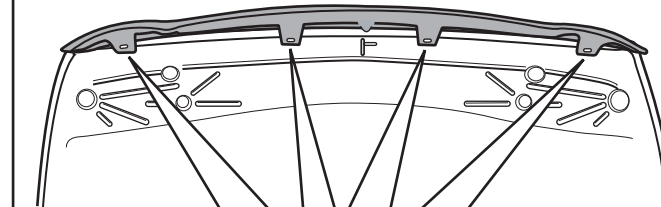

6

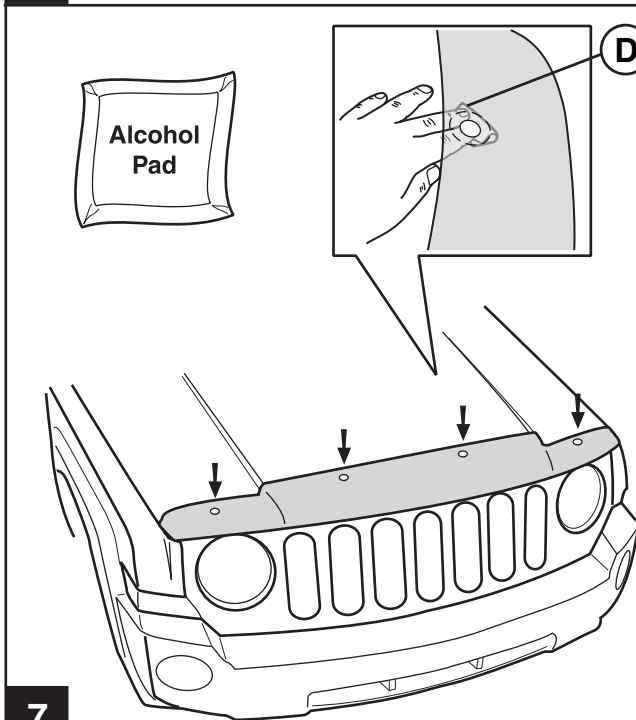

7

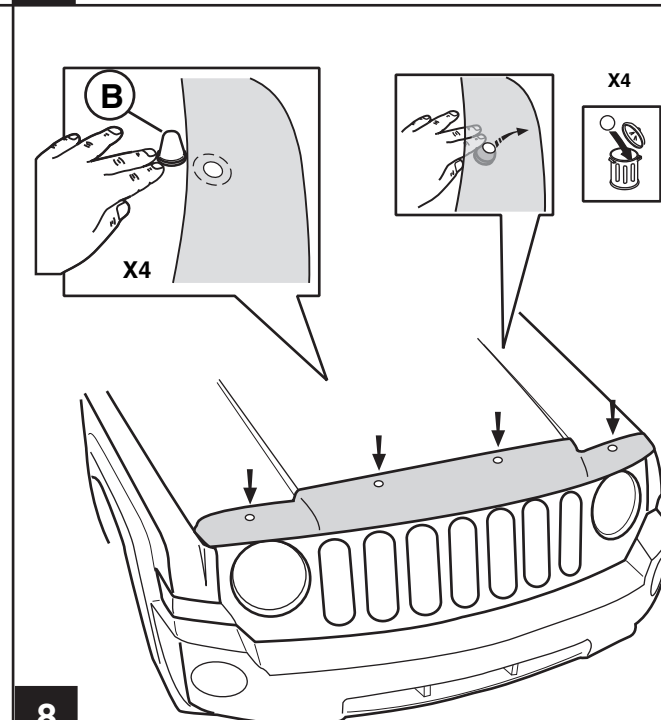

8