

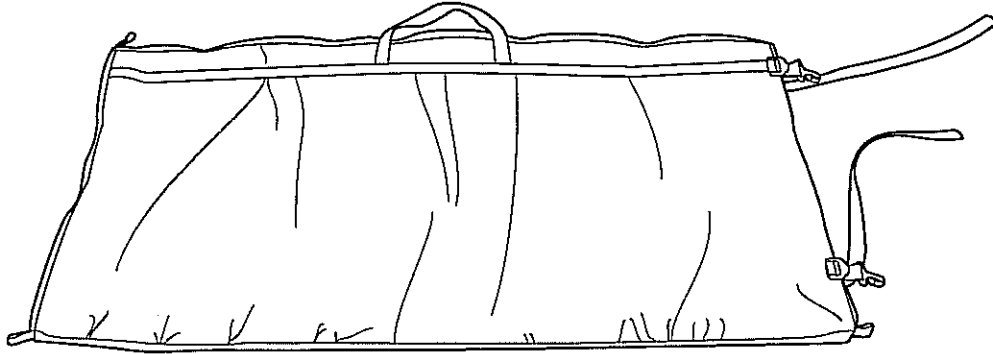

JK WRANGLER

3 Compartment Bag



82210326



K6860048

A

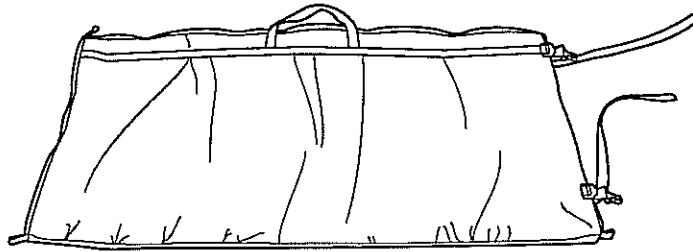

1

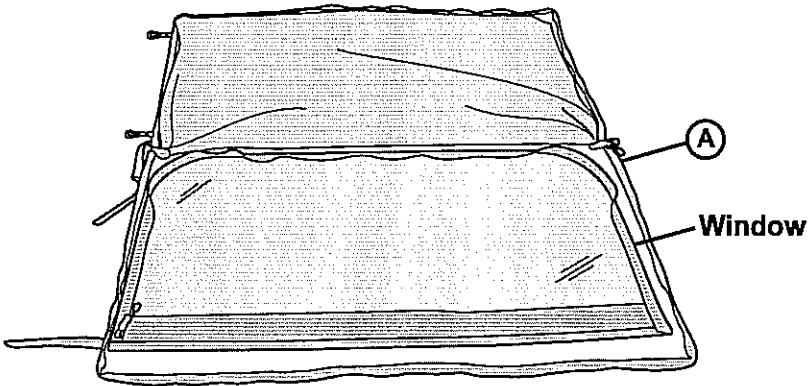

Lay bag out flat.

Lay one window flat.

2

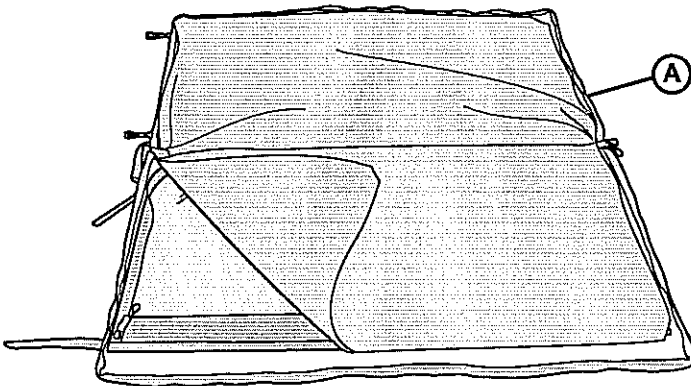

Place protective cover over window.

3

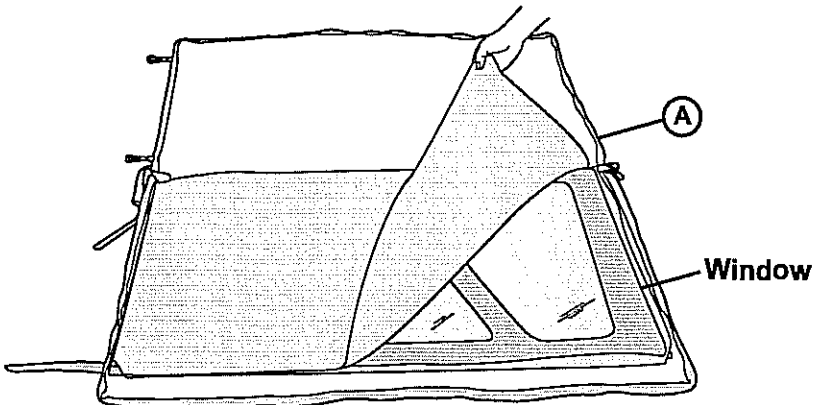

Add additional windows with protective cover between each layer.

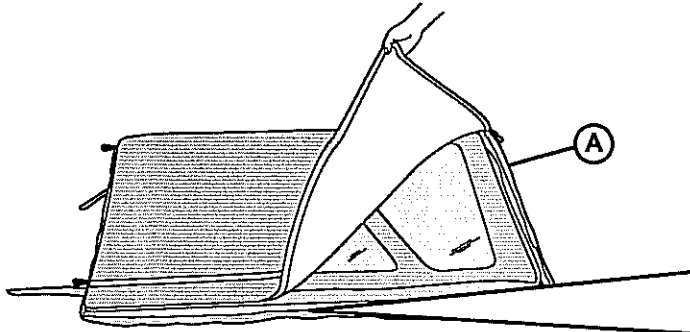

Fold outer flap over and zip closed.

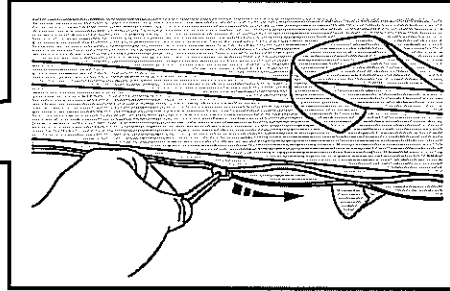

4

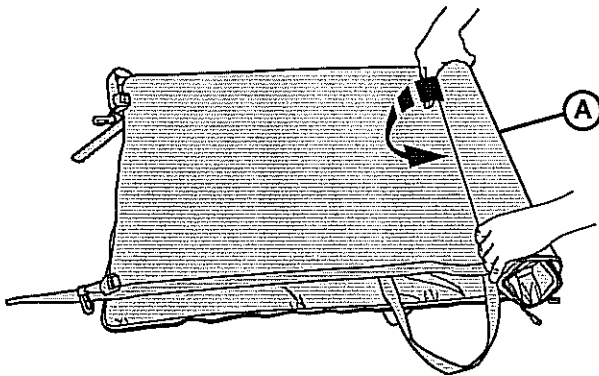

Roll bag as tight as possible.

5

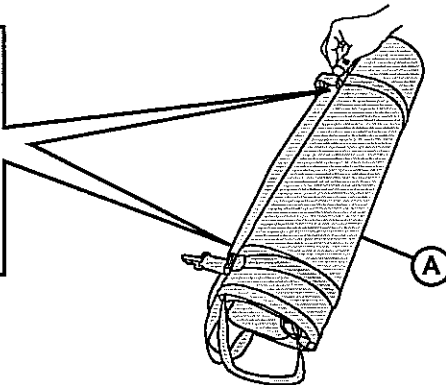
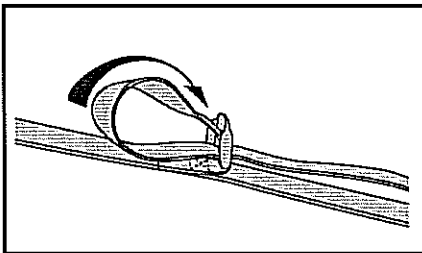

Thread straps through buckles and pull tight.

6

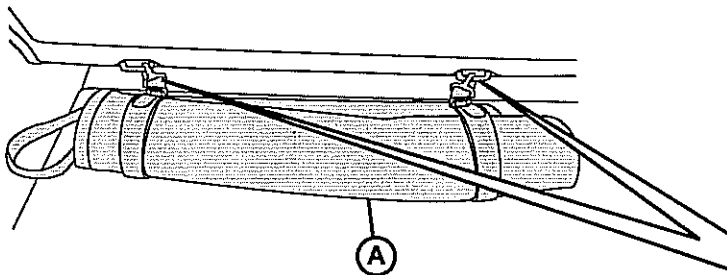

Clip bag to child restraint brackets on back of seat.

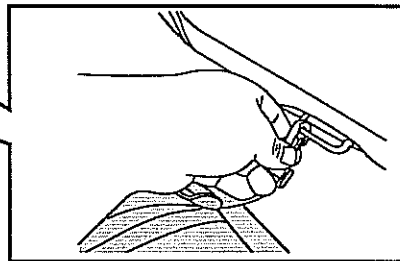

7



JK WRANGLER

Sac à 3 compartiments

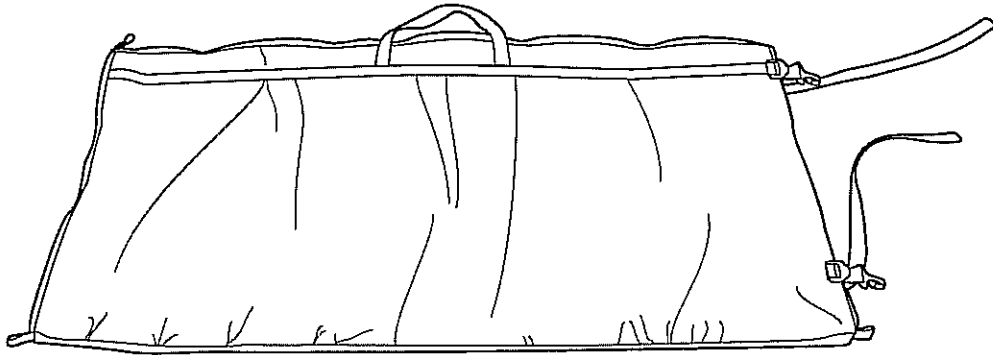

82210326

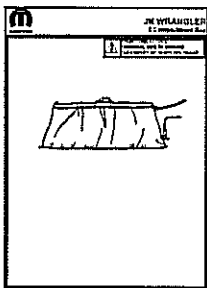

K6860048

A

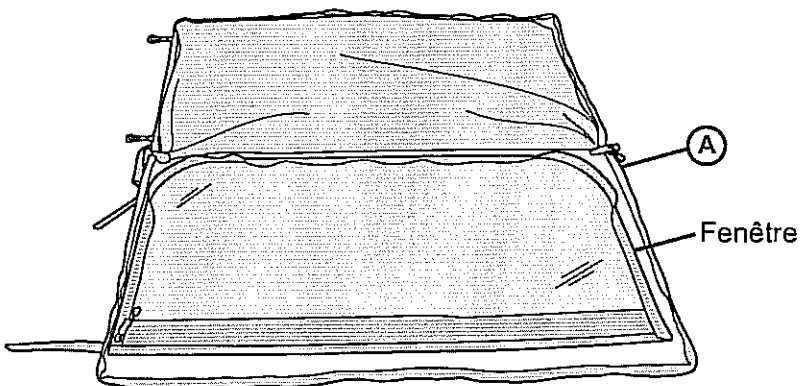
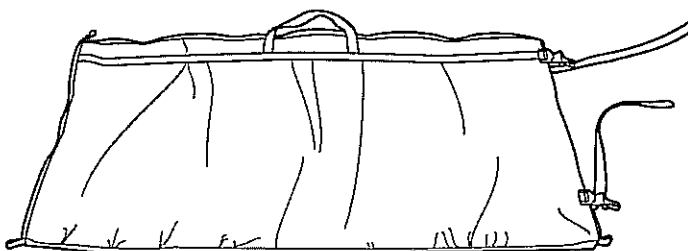

1

Étaler le sac à plat.

Étaler une fenêtre à plat.

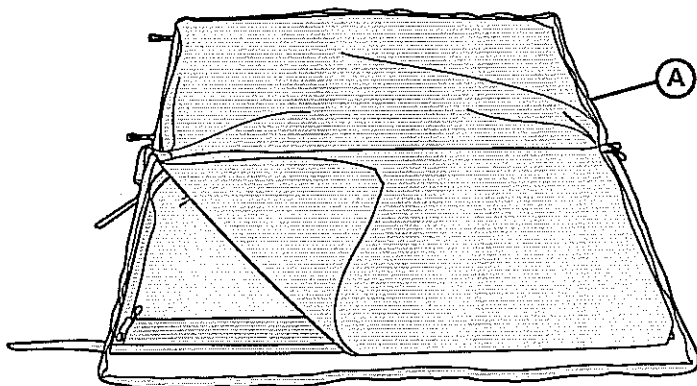

2

Placer la housse de protection par-dessus la fenêtre.

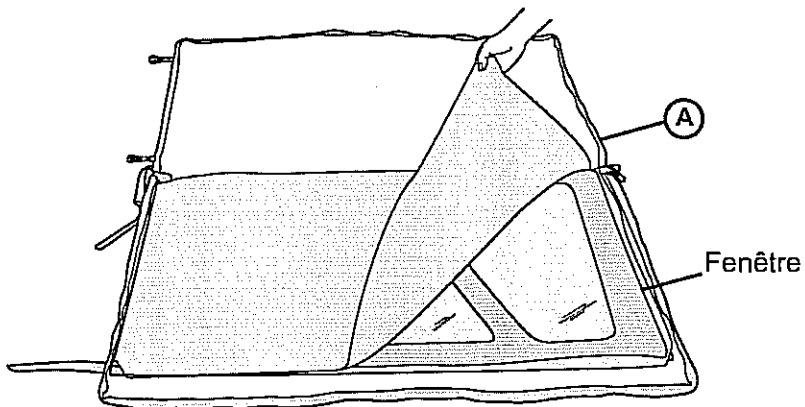

3

Ajouter des fenêtres additionnelles avec une housse de protection entre les couches.

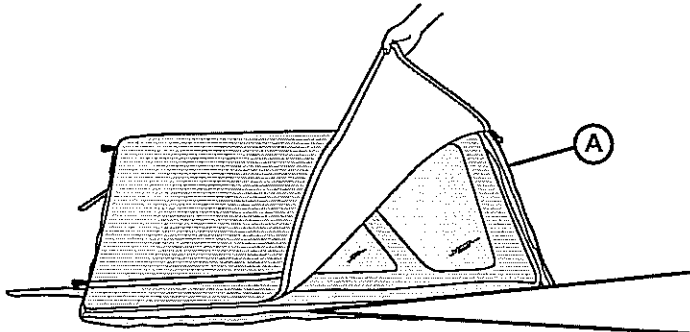

Plier le rabat extérieur par-dessus et fermer avec la fermeture à glissière.

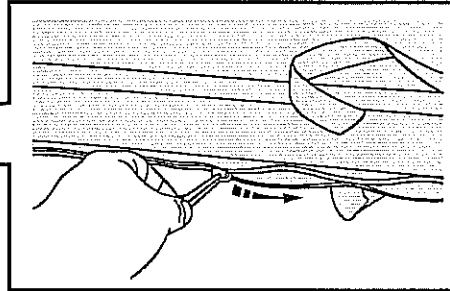

4

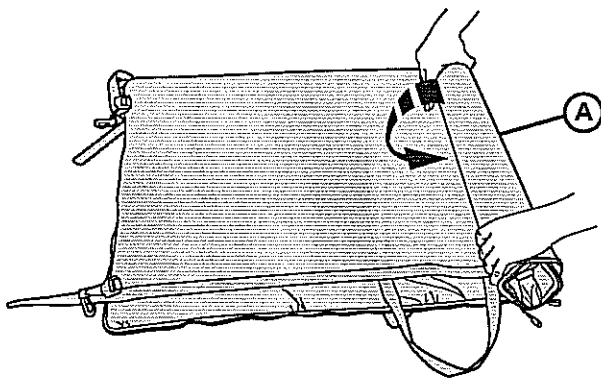

Rouler le sac le plus étroitement possible.

5

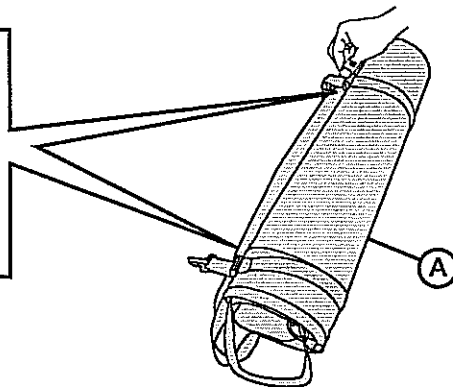
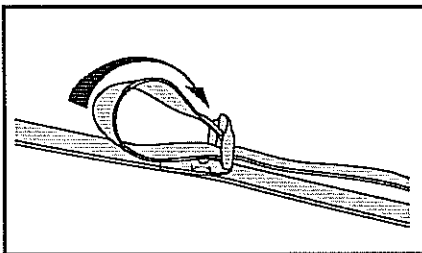

Passer les sangles dans les boucles et tirer pour serrer.

6

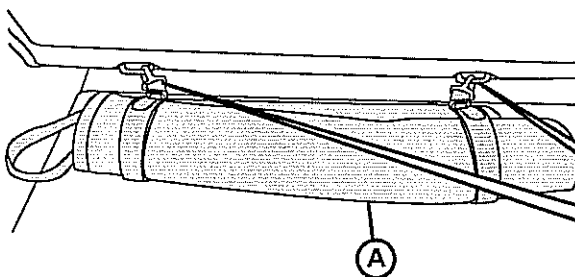

Fixer le sac aux supports de retenue à l'arrière du siège.

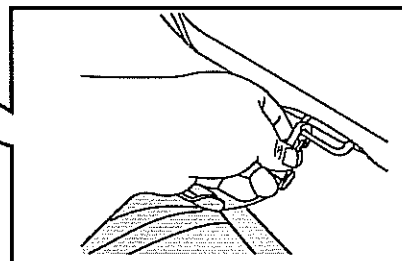

7



JK WRANGLER

Bolso de 3 Compartimientos

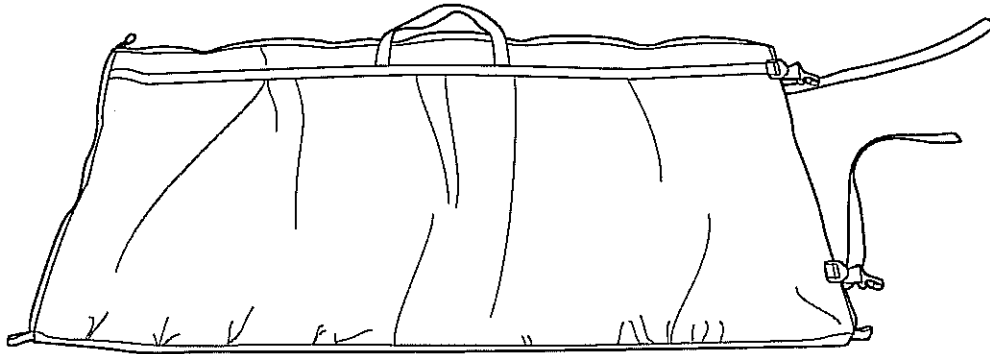

82210326



K6860048

A

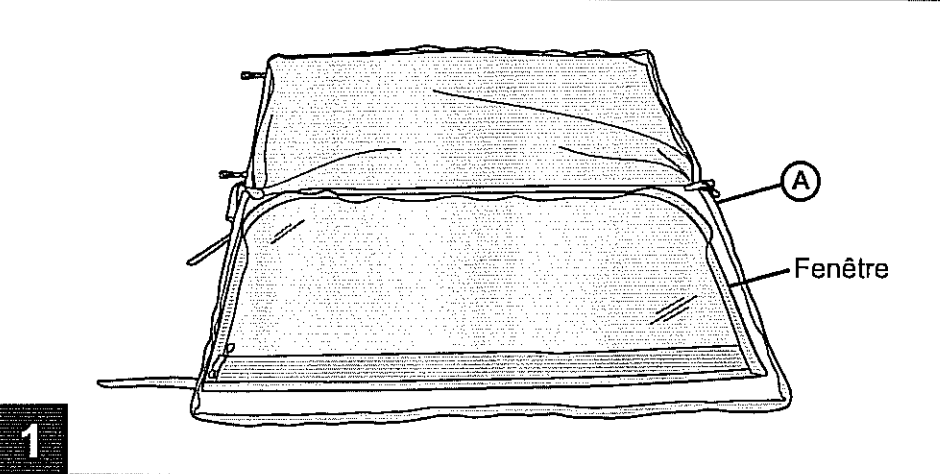
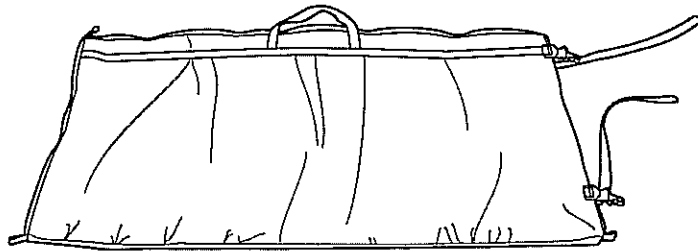

Extienda el bolso completamente.

Extienda una ventana completamente

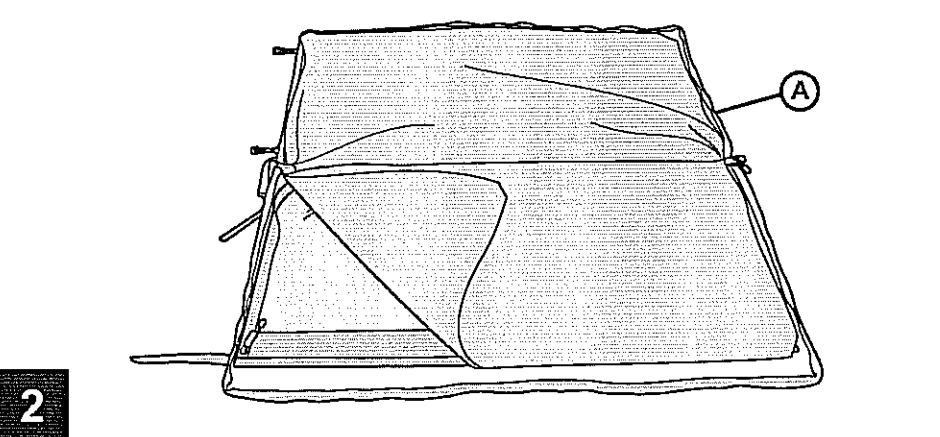

Coloque la cubierta protectora sobre la ventana.

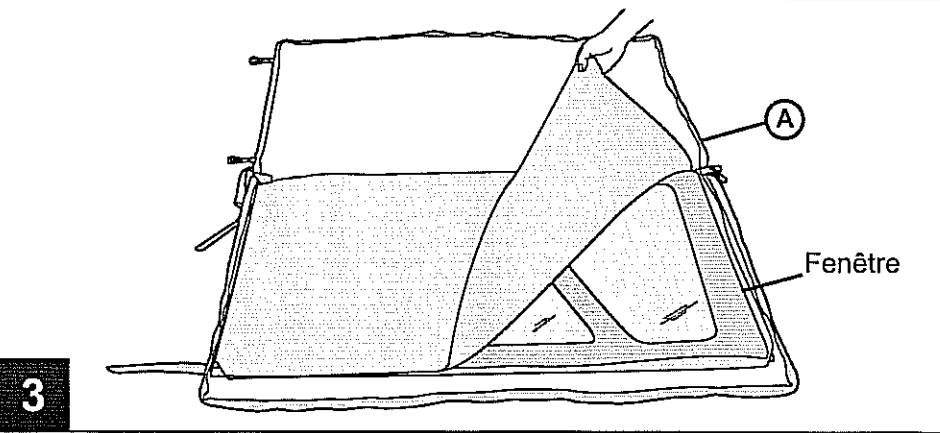

Agregue ventanas con la cubierta protectora entre cada capa

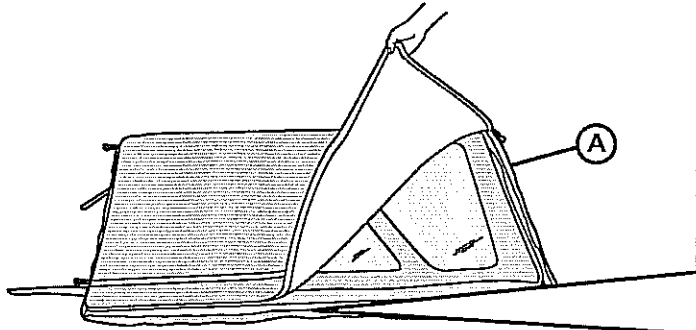

Doble y enfunde la cubierta exterior y cierre la cremallera.

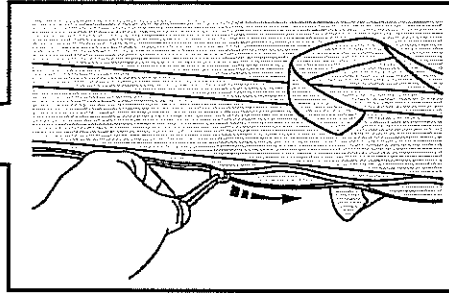

4

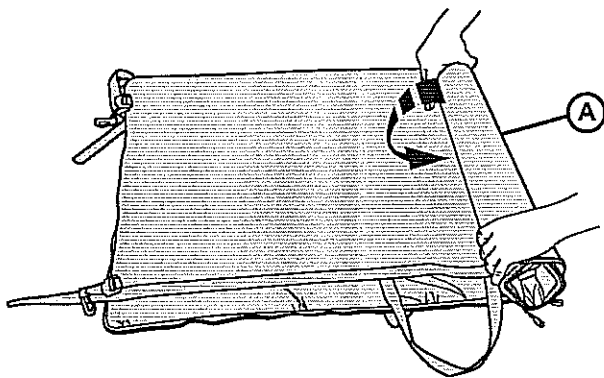

Enrolle el bolso lo más compacto posible.

5

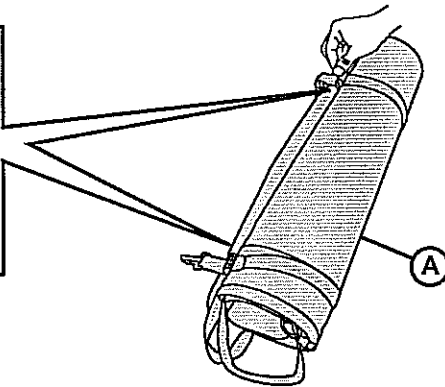
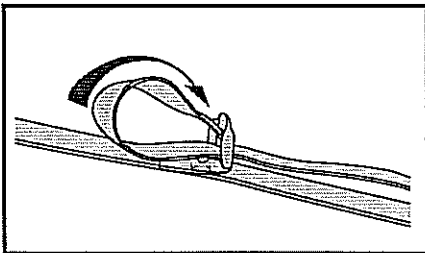

Haga pasar las correas por las hebillas y jale para tensar y ajustar.

6

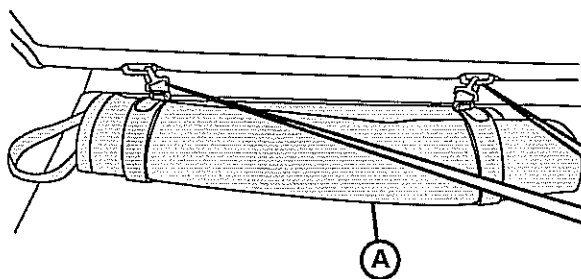

Enganche el bolso a los seguros para niños en la parte de atrás de los asientos.

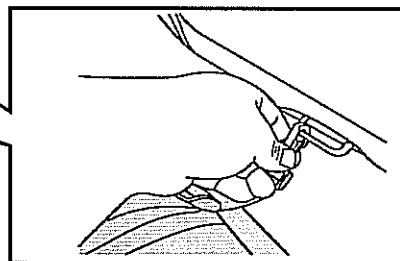

7