

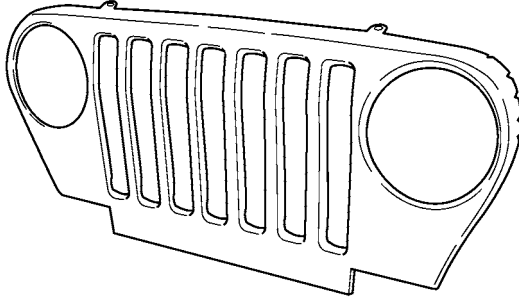

MOPAR®

# JEEP WRANGLER

## Chrome Grille



A



B



C 2x

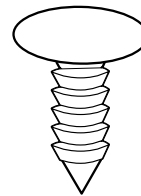

D 2x

T15 

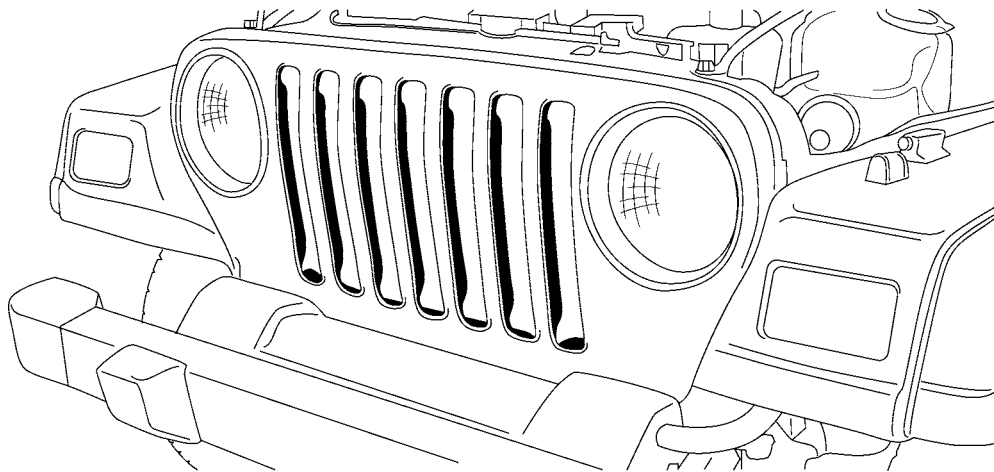
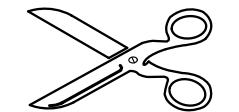
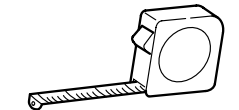
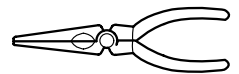
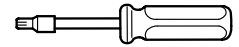

To improve appearance of the chrome grille on light colored vehicles, you may want to paint the areas indicated above with flat black paint. Clean the surfaces and paint to manufacturer's instructions.

Para mejorar el aspecto de la rejilla cromada en vehículos de colores claros, usted puede pintar las áreas indicadas arriba con pintura color negro mate. Limpie las superficies y pinte según las instrucciones del fabricante.

Pour améliorer l'apparence de la calandre chromée des véhicules de couleur claire, vous pouvez peindre les zones indiquées ci-dessus avec de la peinture noire mate. Nettoyez les surfaces, puis appliquez la peinture en suivant les instructions du fabricant.

Um das Aussehen des Kühlergrills bei Fahrzeugen mit heller Lackierung zu verbessern, können Sie die oben angegebenen Bereiche mit schwarzer Grundierfarbe streichen. Reinigen Sie die Oberfläche und tragen Sie die Farbe gemäß den Herstelleranweisungen auf.

1

